



FH300 Issue 5
Metal Halide – 575 w
Manual Control

APPLICATION

The FRANCIS FH range of searchlights incorporate the design features required to successfully operate searchlights in the most demanding product operating environments on land and sea. These units are particularly suitable for use on patrol Craft, custom vessels and security installations.

PART NUMBERS

Type	Supply	L/holder	Part No
FH300 Deck	240v	G22	A2876
FH300 Cabin	240v	G22	A2877
FH300 Deck Ped.	240v	G22	A2878
FH300 Cabin Ped.	240v	G22	A2879

Weights

Deck	16.5 Kg
Cabin	18.5 Kg
Deck Pedestal	20.5 Kg
Cabin Pedestal	22.5 Kg
Control Gear (280 x 190 x 182)	9.5 Kg

SPECIFICATION

- All brass construction.
- Stove enamel painted.
- Parabolic glass reflector.
- Instant lamp re-strike. No cooling down time required.
- External lamp focus adjustment.
- Remote focus mechanism available upon request.
- Toughened front glass.
- Captive bezel / glass.
- Light shield to prevent unwanted glare & stray light.
- Searchlight protected to IP 56
- Control gear protected to IP66.
- Special "B" & "C" dimensions available on request.
- Full 450° rotation.
- Vertical movement +35° to - 25°.
- Luminous flux 49000.
- Colour temperature 6000 K.

Performance Data * Inclusive angle

Volt's	Lamp life	Range (m)	PBCP x1000	*Div	Watts	Lamp Cap	Lamp Part No.
240v	1000 hrs	3685	13600	2.5	575	G22	D15764

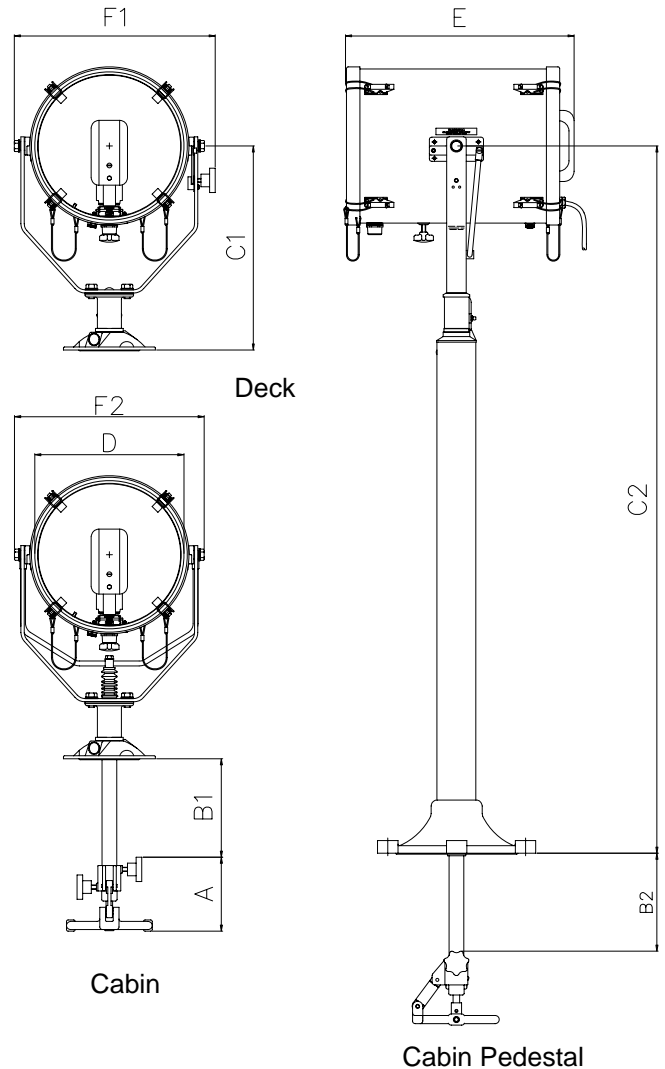

All Dimensions in Millimetres

Deck & Cabin. 3 holes Ø11 on a 154 PCD

Deck Ped. & Cabin Ped 4 holes Ø14.5 on a 270 PCD

Cabin & Cabin Ped. Central hole Ø40

Dimensions

A	B1	B2	C1	C2	D	E	F1	F2
146	195	188	403	1395	300	448	395	374

For more information contact:

Francis Searchlights Limited
 Union Road, Bolton, BL2 2HJ, UK
 Tel 44 (0) 1204 558960 Fax 44 (0) 1204 558979
 Email sales@francis.co.uk Web site www.francis.co.uk